

Аксессуары для напольных шкафов

Поворотные рамы с боковым смещением ELDON ESFS

Технические характеристики



Архангельск (8182)63-90-72
Астана (7172)727-132
Астрахань (8512)99-46-04
Барнаул (3852)73-04-60
Белгород (4722)40-23-64
Брянск (4832)59-03-52
Владивосток (423)249-28-31
Волгоград (844)278-03-48
Вологда (8172)26-41-59
Воронеж (473)204-51-73
Екатеринбург (343)384-55-89
Иваново (4932)77-34-06

Ижевск (3412)26-03-58
Иркутск (395)279-98-46
Казань (843)206-01-48
Калининград (4012)72-03-81
Калуга (4842)92-23-67
Кемерово (3842)65-04-62
Киров (8332)68-02-04
Краснодар (861)203-40-90
Красноярск (391)204-63-61
Курск (4712)77-13-04
Липецк (4742)52-20-81

Киргизия (996)312-96-26-47

Магнитогорск (3519)55-03-13
Москва (495)268-04-70
Мурманск (8152)59-64-93
Набережные Челны (8552)20-53-41
Нижегород (831)429-08-12
Новокузнецк (3843)20-46-81
Новосибирск (383)227-86-73
Омск (3812)21-46-40
Орел (4862)44-53-42
Оренбург (3532)37-68-04
Пенза (8412)22-31-16

Россия (495)268-04-70

Пермь (342)205-81-47
Ростов-на-Дону (863)308-18-15
Рязань (4912)46-61-64
Самара (846)206-03-16
Санкт-Петербург (812)309-46-40
Саратов (845)249-38-78
Севастополь (8692)22-31-93
Симферополь (3652)67-13-56
Смоленск (4812)29-41-54
Сочи (862)225-72-31
Ставрополь (8652)20-65-13

Казахстан (772)734-952-31

Сургут (3462)77-98-35
Тверь (4822)63-31-35
Томск (3822)98-41-53
Тула (4872)74-02-29
Тюмень (3452)66-21-18
Ульяновск (8422)24-23-59
Уфа (347)229-48-12
Хабаровск (4212)92-98-04
Челябинск (351)202-03-61
Череповец (8202)49-02-64
Ярославль (4852)69-52-93

Floor Standing Enclosures Steel Range

Accessories | 19" mounting

Swing Frame side mounted, ESFS

- Description:** Full height swing frame for 19" components allowing left and right hand opening with grip over the full height. Can be used in steel, combinable and compact enclosures. Hinges designed to give extra build-in depth. Adjustable top hinge for square mounting of the swing frame. Rigid W-shaped frame profile for heavy equipment. Zinc plated 19" vertical profiles for direct earthing of the mounted components. Standard equipped with 130° hinges. Full access to the enclosure's aperture can be acquired by use of 180° hinges ESFH180. For mounting use transversal support bars ESFB. Depth support and easy cable routing is achieved with depth mounting plate SFMP. Adjustable in depth by steps of 12.5 mm.
- Maximum load:** 1800 N, supplied with a self-positioning device.
- Lock:** Double-bit 3 mm espagnolette (other lock options possible).
- Material:** 19" vertical profiles 2 mm zinc plated steel. Frame: vertical profiles 2 mm and horizontal profiles 3 mm.
- Finish:** RAL 7035 structured powder coating.
- Pack quantity:** 1 swing frame with hinges.
- Mounting requirements:** ESFS for 800 mm, 1000 mm wide steel, combinable enclosures. Add ESFB for mounting in a steel, combinable enclosure.



For enclosure					
H	U	H1	H2	H3	Item no.
1400	27	1203	1267	1337	ESFS278
1600	31	1381	1445	1515	ESFS318
1800	36	1603	1667	1737	ESFS368
2000	40	1781	1845	1915	ESFS408
2200	45	2003	2067	2137	ESFS458

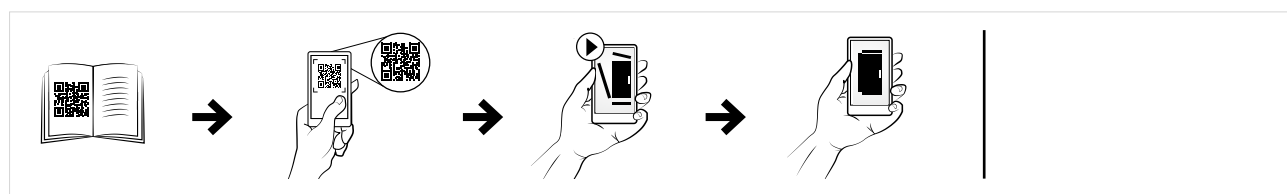



■ Support bars 800/1000 wide

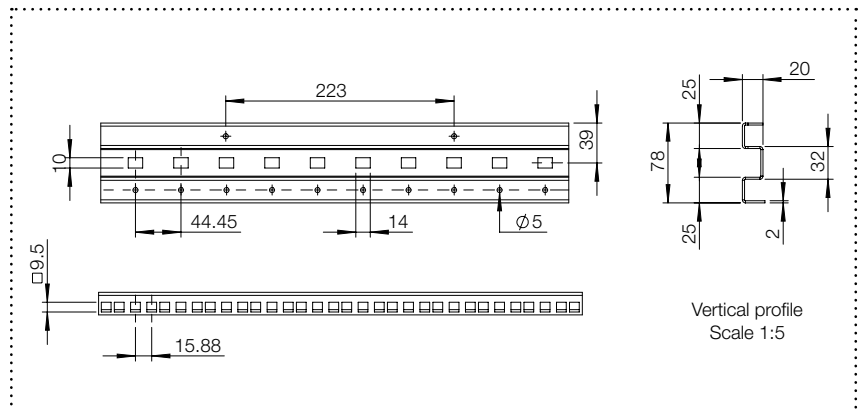
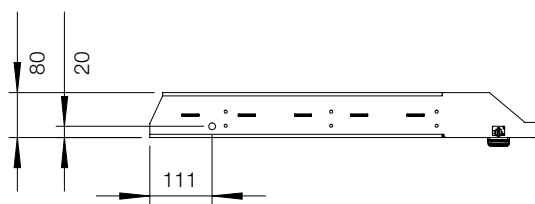
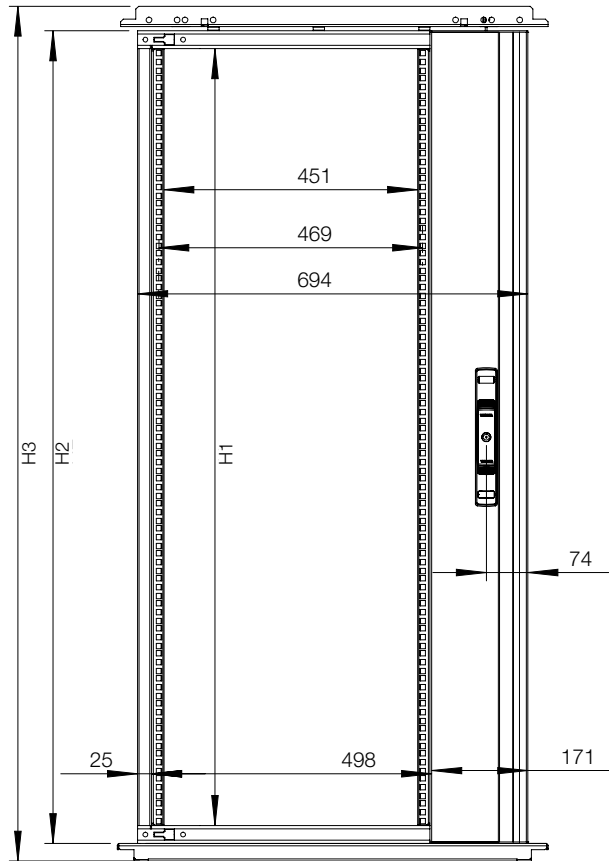

Floor Standing Enclosures Steel Range

Accessories | 19" mounting

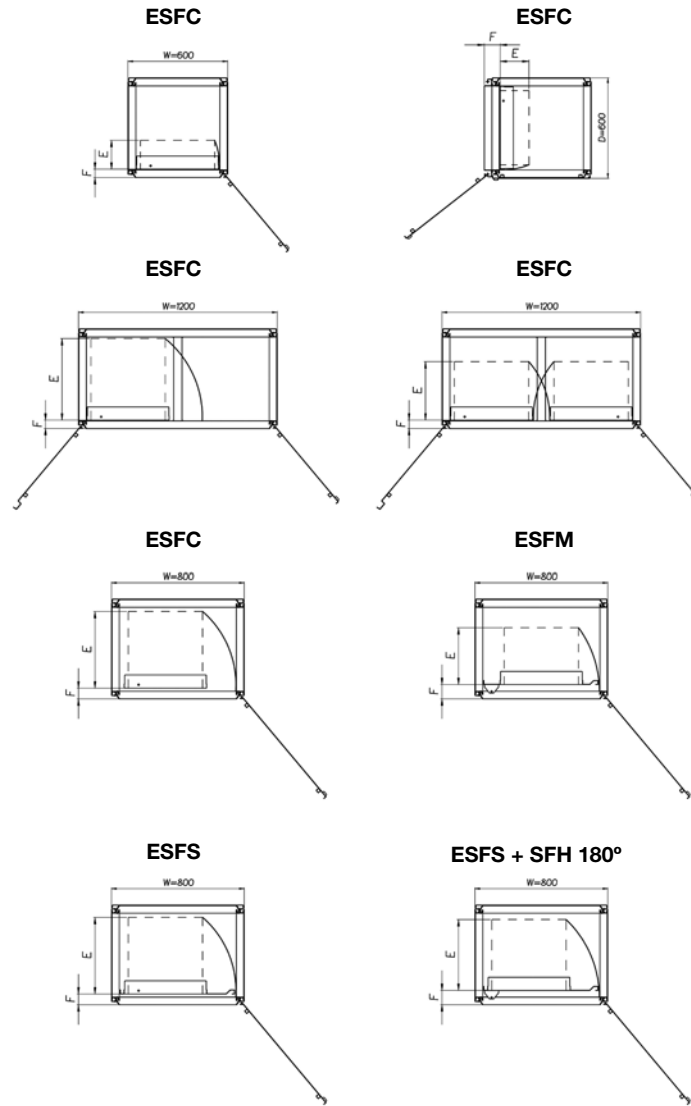

Maximum build-in depth - E

Depth	ESFC	ESFC in 800W	1xESFC in 1200W	2xESFC in 1200W	ESFS	ESFS+SFH 180	ESFM
400	175	280	295	295	280	260	260
500	175	380	395	355	380	360	345
600	175	465	495	355	465	430	345
800	175	465	395	355	465	430	345
F	51	51	51	51	65	86	86

ESFC can also be mounted inside of a 600 deep enclosure in combination with a side door (DS).

Maximum build-in depth - E E=175, F=96.

Maximum opening angle

Item No	Opening angle degrees icw.	Opening angle degrees icw.
ESFC	125	125
ESFC interior	120	120
ESFM + ESFH	120	155
ESFS interior	120	130
ESFS + SFH	180	155

Maximum support per hinge type

Item No	Opening angle degrees icw.	Max. loading (kg)
ESFC	125	150
ESFC	120	150
ESFM + ESFH	180	120
ESFS + ESFH	180	120
ESFS + SFH	180	120

Partial height, Top mounting

Partial height, Middle mounting

Partial height, Bottom mounting

ESFC
Width: 600 mm

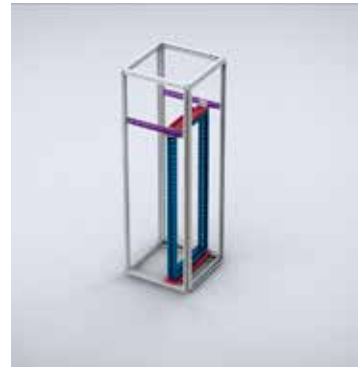

ESFC
Width: 800-1000 mm



ESFC
Width: 1200 mm

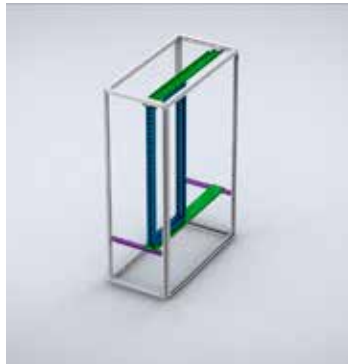

ESFM / ESFS
Width: 800-1000 mm

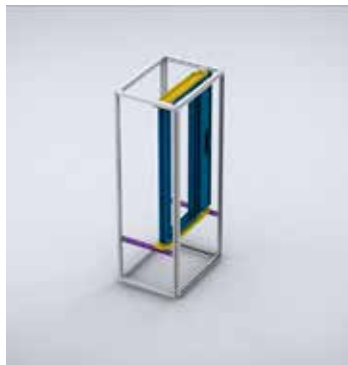

■ Swing frame

■ Support bars 600 wide

■ Support bars 800/1000 wide

■ Support bars 1200 wide

■ Mounting profile

Архангельск (8182)63-90-72
Астана (7172)727-132
Астрахань (8512)99-46-04
Барнаул (3852)73-04-60
Белгород (4722)40-23-64
Брянск (4832)59-03-52
Владивосток (423)249-28-31
Волгоград (844)278-03-48
Вологда (8172)26-41-59
Воронеж (473)204-51-73
Екатеринбург (343)384-55-89
Иваново (4932)77-34-06

Ижевск (3412)26-03-58
Иркутск (395)279-98-46
Казань (843)206-01-48
Калининград (4012)72-03-81
Калуга (4842)92-23-67
Кемерово (3842)65-04-62
Киров (8332)68-02-04
Краснодар (861)203-40-90
Красноярск (391)204-63-61
Курск (4712)77-13-04
Липецк (4742)52-20-81

Киргизия (996)312-96-26-47

Магнитогорск (3519)55-03-13
Москва (495)268-04-70
Мурманск (8152)59-64-93
Набережные Челны (8552)20-53-41
Нижний Новгород (831)429-08-12
Новокузнецк (3843)20-46-81
Новосибирск (383)227-86-73
Омск (3812)21-46-40
Орел (4862)44-53-42
Оренбург (3532)37-68-04
Пенза (8412)22-31-16

Россия (495)268-04-70

Пермь (342)205-81-47
Ростов-на-Дону (863)308-18-15
Рязань (4912)46-61-64
Самара (846)206-03-16
Санкт-Петербург (812)309-46-40
Саратов (845)249-38-78
Севастополь (8692)22-31-93
Симферополь (3652)67-13-56
Смоленск (4812)29-41-54
Сочи (862)225-72-31
Ставрополь (8652)20-65-13

Казахстан (772)734-952-31

Сургут (3462)77-98-35
Тверь (4822)63-31-35
Томск (3822)98-41-53
Тула (4872)74-02-29
Тюмень (3452)66-21-18
Ульяновск (8422)24-23-59
Уфа (347)229-48-12
Хабаровск (4212)92-98-04
Челябинск (351)202-03-61
Череповец (8202)49-02-64
Ярославль (4852)69-52-93