

Напольные шкафы ELDON MCSS одностворчатые

Технические характеристики



Архангельск (8182)63-90-72
Астана (7172)727-132
Астрахань (8512)99-46-04
Барнаул (3852)73-04-60
Белгород (4722)40-23-64
Брянск (4832)59-03-52
Владивосток (423)249-28-31
Волгоград (844)278-03-48
Вологда (8172)26-41-59
Воронеж (473)204-51-73
Екатеринбург (343)384-55-89
Иваново (4932)77-34-06

Ижевск (3412)26-03-58
Иркутск (395)279-98-46
Казань (843)206-01-48
Калининград (4012)72-03-81
Калуга (4842)92-23-67
Кемерово (3842)65-04-62
Киров (8332)68-02-04
Краснодар (861)203-40-90
Красноярск (391)204-63-61
Курск (4712)77-13-04
Липецк (4742)52-20-81

Киргизия (996)312-96-26-47

Магнитогорск (3519)55-03-13
Москва (495)268-04-70
Мурманск (8152)59-64-93
Набережные Челны (8552)20-53-41
Нижний Новгород (831)429-08-12
Новокузнецк (3843)20-46-81
Новосибирск (383)227-86-73
Омск (3812)21-46-40
Орел (4862)44-53-42
Оренбург (3532)37-68-04
Пенза (8412)22-31-16

Россия (495)268-04-70

Пермь (342)205-81-47
Ростов-на-Дону (863)308-18-15
Рязань (4912)46-61-64
Самара (846)206-03-16
Санкт-Петербург (812)309-46-40
Саратов (845)249-38-78
Севастополь (8692)22-31-93
Симферополь (3652)67-13-56
Смоленск (4812)29-41-54
Сочи (862)225-72-31
Ставрополь (8652)20-65-13

Казахстан (772)734-952-31

Сургут (3462)77-98-35
Тверь (4822)63-31-35
Томск (3822)98-41-53
Тула (4872)74-02-29
Тюмень (3452)66-21-18
Ульяновск (8422)24-23-59
Уфа (347)229-48-12
Хабаровск (4212)92-98-04
Челябинск (351)202-03-61
Череповец (8202)49-02-64
Ярославль (4852)69-52-93

Floor Standing Enclosures
Steel Range | Stainless Steel
Combinable, single door | MCSS

IP 55 | TYPE 12, 13 | IK 10



Material:

AISI 304L pre-grained stainless steel / AISI 316L. Frame: 1.5 mm. Door: 2 mm. Rear, roof and side panels: 1.5 mm. Bottom plates: 1.5 mm stainless steel. Mounting plate: 3 mm galvanized steel.

Frame:

Seam welded reversed open profiles with 25 mm hole pattern, according to DIN 43660.

Door:

Mounted with four hinges allowing left or right hand opening. Including door frame with 25 mm hole pattern.

Rear panel:

Fitted by M6 torx screws. Standard facilities for rear door mounting.

Side panels:

Supplied as an accessory.

Roof panel:

Removable.

Lock:

Espagnolette 4-point locking system. Does not interfere with the enclosure inner space. Standard double-bit 3 mm insert. Standard inserts, cylinders, lift handles and T-handle are available as accessories.

Bottom plates:

One piece bottom plate, with injected polyurethane gasket to ensure maximum sealing.

Mounting plate:

Double folded and slides into position. Adjustable in depth by steps of 25 mm, with the MPD02 accessory. Mounting plate is supplied, attached on the outside of the enclosure packaging.

Earthing:

All panels are earthed through their fittings and are equipped with a separate earthing stud.

Finish:

400 pre-grained stainless steel.

Protection:

Corresponds with IP 55 | TYPE 12, 13 | IK 10.

Mounting requirements:

Standard delivery ready for combined installation. For stand-alone installation, add side panels.

Delivery:

Frame with fitted door, rear panel, roof panel, bottom plate, mounting plate and door frame. Delivery also includes earthing bolts. Delivered on a pallet which is identical to the width of the enclosure to allow baying without removal. All packing material is recyclable.



Dimensional table | MCSS

IP 55 | TYPE 12, 13 | IK 10

Enclosure dimensions			Mounting plate dimensions		Item no.
H	W	D	h	w	
1800	600	500	1694	494	MCSS18065
1800	600	500	1694	494	MCSS18065-316
1800	800	500	1694	694	MCSS18085
1800	800	500	1694	694	MCSS18085-316
1800	1000	500	1694	894	MCSS18105
1800	1000	500	1694	894	MCSS18105-316
2000	600	600	1894	494	MCSS20066
2000	600	600	1894	494	MCSS20066-316
2000	800	600	1894	694	MCSS20086
2000	800	600	1894	694	MCSS20086-316
2000	1000	600	1894	894	MCSS20106
2000	1000	600	1894	894	MCSS20106-316

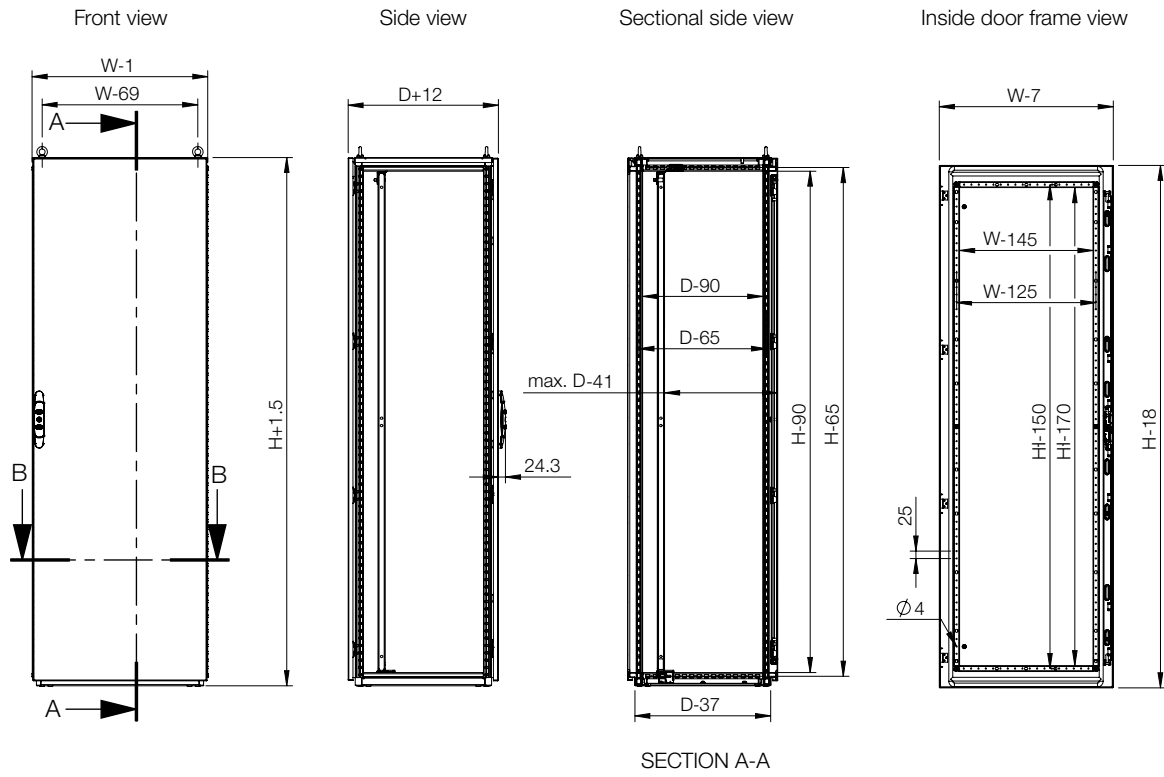

Sectional top view

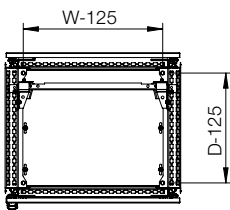

Sectional top view (without bottom plates)

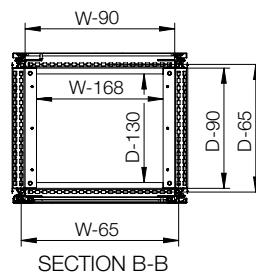



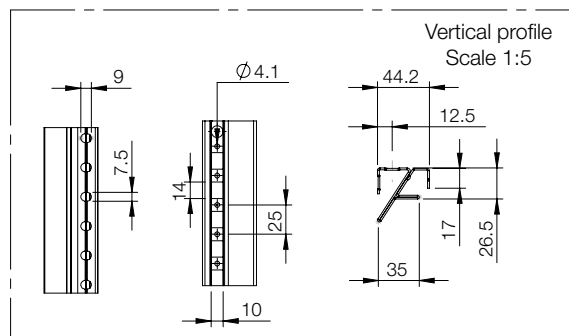
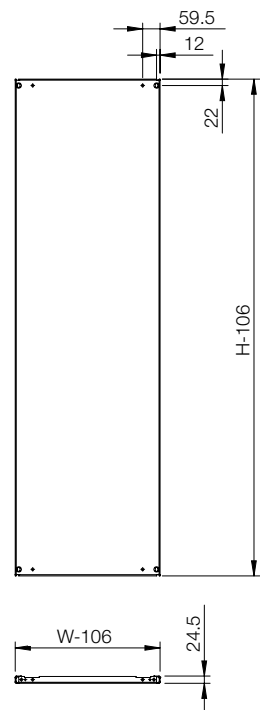



Mounting plate view



Accessories selection matrix | MCSS

									
Enclosure				Mounting					
	H	W	D	Mounting plate	Wide mounting plate *	Transversal sliding profiles	Mounting profiles (19") **	Brackets for fixing 19" mounting profiles	Side mounting bar
MCSS18065	1800	600	500	MP1806	MPW1806	MTS600	CIP38	CIB600	CMB502
MCSS18085	1800	800	500	MP1808	MPW1808	MTS800	CIP38	CIB800	CMB502
MCSS18105	1800	1000	500	MP1810	MPW1810	MTS1000	-	-	CMB502
MCSS20066	2000	600	600	MP2006	MPW2006	MTS600	CIP42	CIB600	CMB602
MCSS20086	2000	800	600	MP2008	MPW2008	MTS800	CIP42	CIB800	CMB602
MCSS20106	2000	1000	600	MP2010	MPW2010	MTS1000	-	-	CMB602

* MTS is required.
** CIB, CID or CIWR are required.

										
Enclosure				Mounting						
	H	W	D	Mounting profile, in H	Mounting profile, in W	Mounting profile, in D	Click in profile, in W	Click in profile, in D	Outer mounting profile, in W	Outer mounting profile, in D
MCSS18065	1800	600	500	CLPF1800	CLPF600	CLPF500	CLPK600	CLPK500	CLPO600	CLPO500
MCSS18085	1800	800	500	CLPF1800	CLPF800	CLPF500	CLPK800	CLPK500	CLPO800	CLPO500
MCSS18105	1800	1000	500	CLPF1800	CLPF1000	CLPF500	CLPK1000	CLPK500	CLPO1000	CLPO500
MCSS20066	2000	600	600	CLPF2000	CLPF600	CLPF600	CLPK600	CLPK600	CLPO600	CLPO600
MCSS20086	2000	800	600	CLPF2000	CLPF800	CLPF600	CLPK800	CLPK600	CLPO800	CLPO600
MCSS20106	2000	1000	600	CLPF2000	CLPF1000	CLPF600	CLPK1000	CLPK600	CLPO1000	CLPO600

							
Enclosure				Fixing			
	H	W	D	Full height swing frame *	Swing frame middle mounted *	Swing frame side mounted *	Swing frame transversal support bars
MCSS18065	1800	600	500	ESFC366	-	-	ESFB06
MCSS18085	1800	800	500	ESFC366	ESFM368	ESFS368	ESFB08
MCSS18105	1800	1000	500	ESFC366	ESFM368	ESFS368	ESFB10
MCSS20066	2000	600	600	ESFC406	-	-	ESFB06
MCSS20086	2000	800	600	ESFC406	ESFM408	ESFS408	ESFB08
MCSS20106	2000	1000	600	ESFC406	ESFM408	ESFS408	ESFB10

* ESFB is required.

Enclosure	Fixing						
	H	W	D	Front/rear plinths (100 mm height)	Plinth side panels (100 mm height)	Front/rear plinths (200 mm height)	Plinth side panels (200 mm height)
MCSS18065	1800	600	500	PFS1060	PSS1050	PFS2060	PSS2050
MCSS18085	1800	800	500	PFS1080	PSS1050	PFS2080	PSS2050
MCSS18105	1800	1000	500	PFS1100	PSS1050	PFS2100	PSS2050
MCSS20066	2000	600	600	PFS1060	PSS1060	PFS2060	PSS2060
MCSS20086	2000	800	600	PFS1080	PSS1060	PFS2080	PSS2060
MCSS20106	2000	1000	600	PFS1100	PSS1060	PFS2100	PSS2060

Enclosure				Doors			Baying		Cable
	H	W	D	Plain door *	Glazed door *	Inner door	Side panels	Segregation plate **	Cable fixing bar (mounted above bottom plates)
MCSS18065	1800	600	500	DNSS1806	DNGS1806	DI1806R5	SPMS1805	SPDS1805	CAB600
MCSS18085	1800	800	500	DNSS1808	DNGS1808	DI1808R5	SPMS1805	SPDS1805	CAB800
MCSS18105	1800	1000	500	DNSS1810	DNGS1810	-	SPMS1805	SPDS1805	CAB1000
MCSS20066	2000	600	600	DNSS2006	DNGS2006	DI2006R5	SPMS2006	SPDS2006	CAB600
MCSS20086	2000	800	600	DNSS2008	DNGS2008	DI2008R5	SPMS2006	SPDS2006	CAB800
MCSS20106	2000	1000	600	DNSS2010	DNGS2010	-	SPMS2006	SPDS2006	CAB1000

* DNMS is required for each additional door.
** CCJ is required.

Архангельск (8182)63-90-72
Астана (7172)727-132
Астрахань (8512)99-46-04
Барнаул (3852)73-04-60
Белгород (4722)40-23-64
Брянск (4832)59-03-52
Владивосток (423)249-28-31
Волгоград (844)278-03-48
Вологда (8172)26-41-59
Воронеж (473)204-51-73
Екатеринбург (343)384-55-89
Иваново (4932)77-34-06

Ижевск (3412)26-03-58
Иркутск (395)279-98-46
Казань (843)206-01-48
Калининград (4012)72-03-81
Калуга (4842)92-23-67
Кемерово (3842)65-04-62
Киров (8332)68-02-04
Краснодар (861)203-40-90
Красноярск (391)204-63-61
Курск (4712)77-13-04
Липецк (4742)52-20-81

Киргизия (996)312-96-26-47

Магнитогорск (3519)55-03-13
Москва (495)268-04-70
Мурманск (8152)59-64-93
Набережные Челны (8552)20-53-41
Нижегород (831)429-08-12
Новокузнецк (3843)20-46-81
Новосибирск (383)227-86-73
Омск (3812)21-46-40
Орел (4862)44-53-42
Оренбург (3532)37-68-04
Пенза (8412)22-31-16

Россия (495)268-04-70

Пермь (342)205-81-47
Ростов-на-Дону (863)308-18-15
Рязань (4912)46-61-64
Самара (846)206-03-16
Санкт-Петербург (812)309-46-40
Саратов (845)249-38-78
Севастополь (8692)22-31-93
Симферополь (3652)67-13-56
Смоленск (4812)29-41-54
Сочи (862)225-72-31
Ставрополь (8652)20-65-13

Казахстан (772)734-952-31

Сургут (3462)77-98-35
Тверь (4822)63-31-35
Томск (3822)98-41-53
Тула (4872)74-02-29
Тюмень (3452)66-21-18
Ульяновск (8422)24-23-59
Уфа (347)229-48-12
Хабаровск (4212)92-98-04
Челябинск (351)202-03-61
Череповец (8202)49-02-64
Ярославль (4852)69-52-93