

Напольные шкафы ELDON EKSS одностворчатые

Технические характеристики



Архангельск (8182)63-90-72
Астана (7172)727-132
Астрахань (8512)99-46-04
Барнаул (3852)73-04-60
Белгород (4722)40-23-64
Брянск (4832)59-03-52
Владивосток (423)249-28-31
Волгоград (844)278-03-48
Вологда (8172)26-41-59
Воронеж (473)204-51-73
Екатеринбург (343)384-55-89
Иваново (4932)77-34-06

Ижевск (3412)26-03-58
Иркутск (395)279-98-46
Казань (843)206-01-48
Калининград (4012)72-03-81
Калуга (4842)92-23-67
Кемерово (3842)65-04-62
Киров (8332)68-02-04
Краснодар (861)203-40-90
Красноярск (391)204-63-61
Курск (4712)77-13-04
Липецк (4742)52-20-81

Киргизия (996)312-96-26-47

Магнитогорск (3519)55-03-13
Москва (495)268-04-70
Мурманск (8152)59-64-93
Набережные Челны (8552)20-53-41
Нижний Новгород (831)429-08-12
Новокузнецк (3843)20-46-81
Новосибирск (383)227-86-73
Омск (3812)21-46-40
Орел (4862)44-53-42
Оренбург (3532)37-68-04
Пенза (8412)22-31-16

Россия (495)268-04-70

Пермь (342)205-81-47
Ростов-на-Дону (863)308-18-15
Рязань (4912)46-61-64
Самара (846)206-03-16
Санкт-Петербург (812)309-46-40
Саратов (845)249-38-78
Севастополь (8692)22-31-93
Симферополь (3652)67-13-56
Смоленск (4812)29-41-54
Сочи (862)225-72-31
Ставрополь (8652)20-65-13

Казахстан (772)734-952-31

Сургут (3462)77-98-35
Тверь (4822)63-31-35
Томск (3822)98-41-53
Тула (4872)74-02-29
Тюмень (3452)66-21-18
Ульяновск (8422)24-23-59
Уфа (347)229-48-12
Хабаровск (4212)92-98-04
Челябинск (351)202-03-61
Череповец (8202)49-02-64
Ярославль (4852)69-52-93

Floor Standing Enclosures
Steel Range | Stainless Steel
Compact, single door | EKSS

IP 66 | TYPE 4X, 12, 13 | IK 10



Material:

AISI 304 pre-grained stainless steel / AISI 316L. Body and removable rear panel: 1.5 mm. Door: 2 mm. Bottom plate: 1.5 mm. Mounting plate: 3 mm galvanized steel.

Body:

One piece enclosure body. Integrated depth profiles with hole pattern, allowing mounting plate adjustable in depth.

Door:

Surface mounted with 4 hinges allowing left or right hand opening. Including door frame with 25 mm hole pattern and earthing studs.

Rear panel:

Fitted by M6 torx screws. Standard facilities for rear door mounting.

Lock:

External espagnolette 4-point locking system. Standard fitted double-bit 3 mm insert. Standard inserts, cylinders, lift handles and T-handles are available as accessories.

Bottom plates:

One piece bottom plate, with injected polyurethane gasket to ensure maximum sealing.

Mounting plate:

Double folded and slides into position. Adjustable in depth by steps of 25 mm with the MPD02 accessory. Mounting plate is supplied, attached on the outside of the enclosure packaging.

Earthing:

Door is equipped with separate welded earthing studs and earthing to the frame can be accomplished by using the ECF.

Finish:

400 pre-grained stainless steel.

Protection:

Complies with IP 66 | TYPE 4X, 12, 13 | IK 10.

Delivery:

One piece body with fitted door, bottom plate and mounting plate, including door earthing studs. Delivered on a pallet which is identical to the width of the enclosure. Mounting plate is attached to the outside of the enclosure packaging. All the packing material is recyclable.



Dimensional table | EKSS

IP 66 | TYPE 4X, 12, 13 | IK 10

Enclosure dimensions			Mounting plate dimensions		Item no.
H	W	D	h	w	
1400	800	400	1294	694	EKSS14084
1400	800	400	1294	694	EKSS14084-316
1600	600	400	1494	494	EKSS16064
1600	600	400	1494	494	EKSS16064-316
1600	800	400	1494	694	EKSS16084
1600	800	400	1494	694	EKSS16084-316
1600	1000	400	1494	894	EKSS16104
1600	1000	400	1494	894	EKSS16104-316
1800	600	400	1694	494	EKSS18064
1800	600	400	1694	494	EKSS18064-316
1800	800	400	1694	694	EKSS18084
1800	800	400	1694	694	EKSS18084-316
1800	1000	400	1694	894	EKSS18104
1800	1000	400	1694	894	EKSS18104-316
2000	800	400	1894	694	EKSS20084
2000	800	400	1894	694	EKSS20084-316
2000	1000	400	1894	894	EKSS20104
2000	1000	400	1894	894	EKSS20104-316

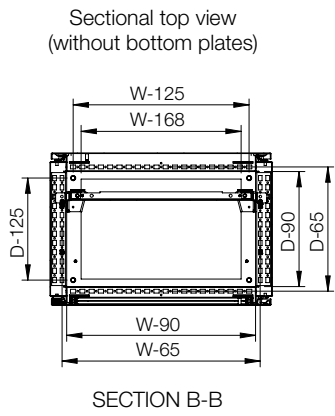
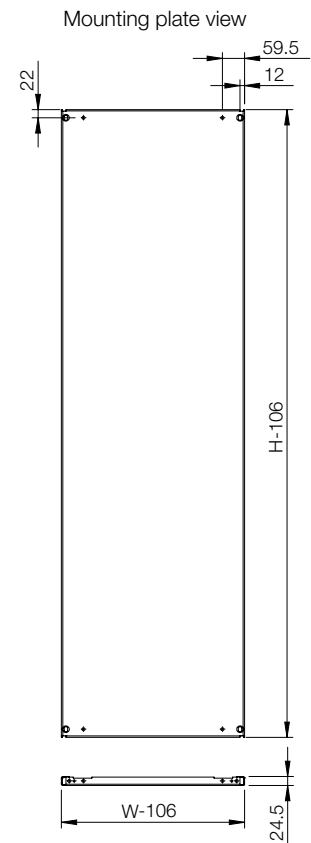
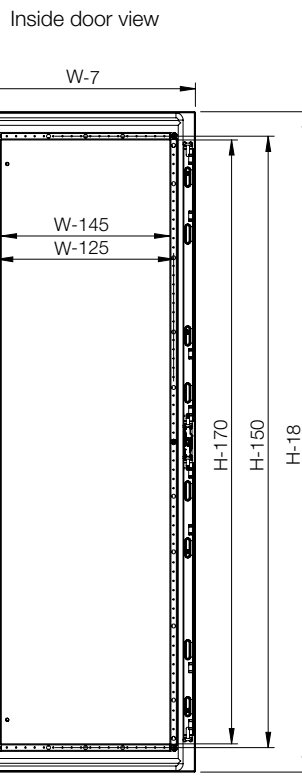
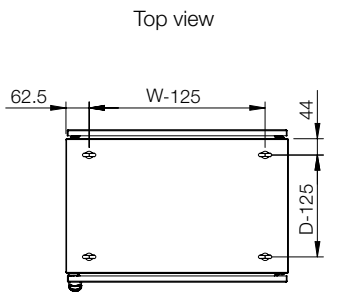
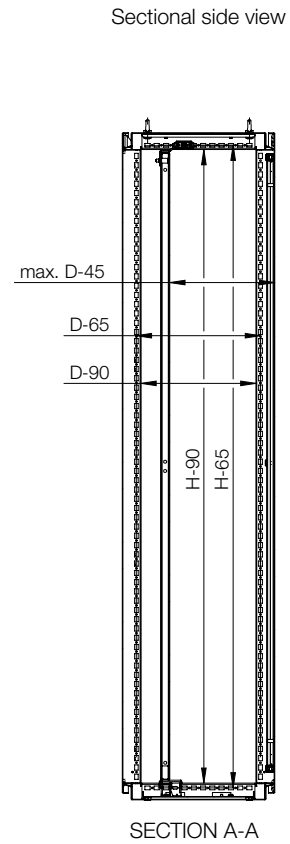
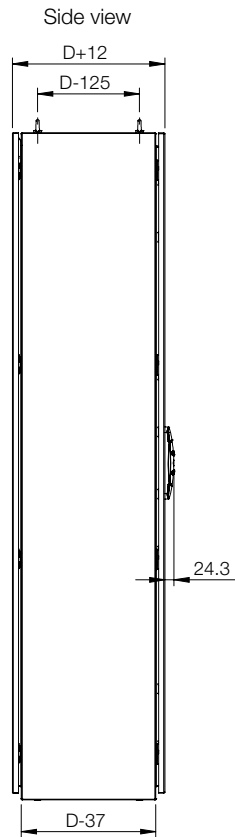
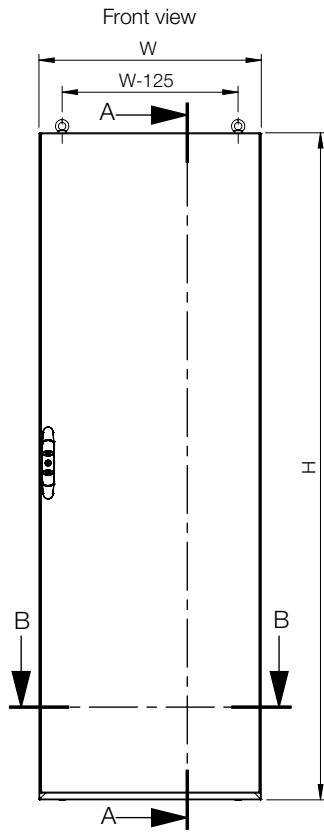

Accessories selection matrix | EKSS

Enclosure				Mounting							
H	W	D	Mounting plate	Mounting profile, in H	Mounting profile, in W	Mounting profile, in D *	Click in profile, in W *	Click in profile, in D	Side mounting bar	Outer mounting profile, in W	
EKSS14084	1400	800	400	MP1408	CLPF1400	CLPF800	CLPF400	CLPK800	CLPK400	CMB402	CLPO800
EKSS16064	1600	600	400	MP1606	CLPF1600	CLPF600	CLPF400	CLPK600	CLPK400	CMB402	CLPO600
EKSS16084	1600	800	400	MP1608	CLPF1600	CLPF800	CLPF400	CLPK800	CLPK400	CMB402	CLPO800
EKSS16104	1600	1000	400	MP1610	CLPF1600	CLPF1000	CLPF400	CLPK1000	CLPK400	CMB402	CLPO1000
EKSS18064	1800	600	400	MP1806	CLPF1800	CLPF600	CLPF400	CLPK600	CLPK400	CMB402	CLPO600
EKSS18084	1800	800	400	MP1808	CLPF1800	CLPF800	CLPF400	CLPK800	CLPK400	CMB402	CLPO800
EKSS18104	1800	1000	400	MP1810	CLPF1800	CLPF1000	CLPF400	CLPK1000	CLPK400	CMB402	CLPO1000
EKSS20084	2000	800	400	MP2008	CLPF2000	CLPF800	CLPF400	CLPK800	CLPK400	CMB402	CLPO800
EKSS20104	2000	1000	400	MP2010	CLPF2000	CLPF1000	CLPF400	CLPK1000	CLPK400	CMB402	CLPO1000

* For compact (EKSS/EKDS) the CLPF in depth or a CLPK in width should be used in combination with CAK02 (Profile bracket for compact enclosures).

Enclosure				Mounting					
H	W	D	Full height swing frame *	Swing frame middle mounted *	Swing frame side mounted *	Swing frame transversal support bars	Mounting profiles (19") **	Brackets for fixing 19" mounting profiles	
EKSS14084	1400	800	400	ESFC276	ESFM278	ESFS278	ESFB08	CIP29	CIB800
EKSS16064	1600	600	400	ESFC316	-	-	ESFB06	CIP33	CIB600
EKSS16084	1600	800	400	ESFC316	ESFM318	ESFS318	ESFB08	CIP33	CIB800
EKSS16104	1600	1000	400	ESFC316	ESFM318	ESFS318	ESFB10	-	-
EKSS18064	1800	600	400	ESFC366	-	-	ESFB06	CIP38	CIB600
EKSS18084	1800	800	400	ESFC366	ESFM368	ESFS368	ESFB08	CIP38	CIB800
EKSS18104	1800	1000	400	ESFC366	ESFM368	ESFS368	ESFB10	-	-
EKSS20084	2000	800	400	ESFC406	ESFM408	ESFS408	ESFB08	CIP42	CIB800
EKSS20104	2000	1000	400	ESFC406	ESFM408	ESFS408	ESFB10	-	-

* ESFB is required.
** CIB, CID or CIWR are required.

Enclosure	Fixing						
	H	W	D	Front/rear plinths (100 mm height)	Plinth side panels (100 mm height)	Front/rear plinths (200 mm height)	Plinth side panels (200 mm height)
	EKSS14084	1400	800	400	PFS1080	PSS1040	PFS2080
EKSS16064	1600	600	400	PFS1060	PSS1040	PFS2060	PSS2040
EKSS16084	1600	800	400	PFS1080	PSS1040	PFS2080	PSS2040
EKSS16104	1600	1000	400	PFS1100	PSS1040	PFS2100	PSS2040
EKSS18064	1800	600	400	PFS1060	PSS1040	PFS2060	PSS2040
EKSS18084	1800	800	400	PFS1080	PSS1040	PFS2080	PSS2040
EKSS18104	1800	1000	400	PFS1100	PSS1040	PFS2100	PSS2040
EKSS20084	2000	800	400	PFS1080	PSS1040	PFS2080	PSS2040
EKSS20104	2000	1000	400	PFS1100	PSS1040	PFS2100	PSS2040

Enclosure				Doors		Cable
	H	W	D	Plain door *	Glazed door *	Cable fixing bar (mounted above bottom plates)
	EKSS14084	1400	800	400	DNSS1408	DNGS1408
EKSS16064	1600	600	400	DNSS1606	DNGS1606	CAB600
EKSS16084	1600	800	400	DNSS1608	DNGS1608	CAB800
EKSS16104	1600	1000	400	DNSS1610	DNGS1610	CAB1000
EKSS18064	1800	600	400	DNSS1806	DNGS1806	CAB600
EKSS18084	1800	800	400	DNSS1808	DNGS1808	CAB800
EKSS18104	1800	1000	400	DNSS1810	DNGS1810	CAB1000
EKSS20084	2000	800	400	DNSS2008	DNGS2008	CAB800
EKSS20104	2000	1000	400	DNSS2010	DNGS2010	CAB1000

* DNMSK is required for each additional door.

Архангельск (8182)63-90-72
 Астана (7172)727-132
 Астрахань (8512)99-46-04
 Барнаул (3852)73-04-60
 Белгород (4722)40-23-64
 Брянск (4832)59-03-52
 Владивосток (423)249-28-31
 Волгоград (844)278-03-48
 Вологда (8172)26-41-59
 Воронеж (473)204-51-73
 Екатеринбург (343)384-55-89
 Иваново (4932)77-34-06

Ижевск (3412)26-03-58
 Иркутск (395)279-98-46
 Казань (843)206-01-48
 Калининград (4012)72-03-81
 Калуга (4842)92-23-67
 Кемерово (3842)65-04-62
 Киров (8332)68-02-04
 Краснодар (861)203-40-90
 Красноярск (391)204-63-61
 Курск (4712)77-13-04
 Липецк (4742)52-20-81

Киргизия (996)312-96-26-47

Магнитогорск (3519)55-03-13
 Москва (495)268-04-70
 Мурманск (8152)59-64-93
 Набережные Челны (8552)20-53-41
 Нижний Новгород (831)429-08-12
 Новокузнецк (3843)20-46-81
 Новосибирск (383)227-86-73
 Омск (3812)21-46-40
 Орел (4862)44-53-42
 Оренбург (3532)37-68-04
 Пенза (8412)22-31-16

Россия (495)268-04-70

Пермь (342)205-81-47
 Ростов-на-Дону (863)308-18-15
 Рязань (4912)46-61-64
 Самара (846)206-03-16
 Санкт-Петербург (812)309-46-40
 Саратов (845)249-38-78
 Севастополь (8692)22-31-93
 Симферополь (3652)67-13-56
 Смоленск (4812)29-41-54
 Сочи (862)225-72-31
 Ставрополь (8652)20-65-13

Казахстан (772)734-952-31

Сургут (3462)77-98-35
 Тверь (4822)63-31-35
 Томск (3822)98-41-53
 Тула (4872)74-02-29
 Тюмень (3452)66-21-18
 Ульяновск (8422)24-23-59
 Уфа (347)229-48-12
 Хабаровск (4212)92-98-04
 Челябинск (351)202-03-61
 Череповец (8202)49-02-64
 Ярославль (4852)69-52-93